

Kit 1443

LAND ROVER Freelander 2, 5-dr SUV, 07-
LAND ROVER LR2, 5-dr SUV, *07-

*North America

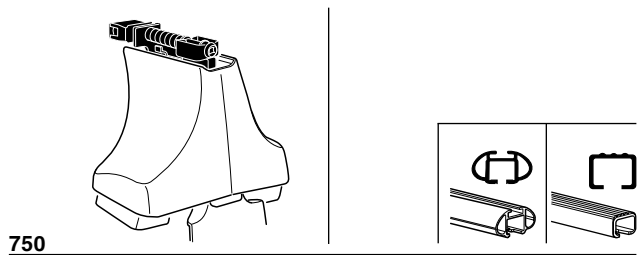
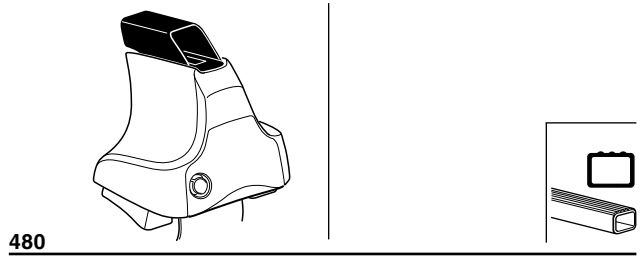
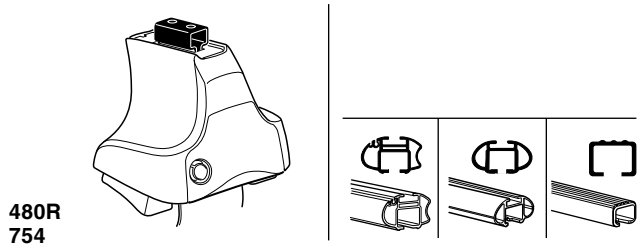

x2 x2 x2 x4	x2	x2 x2 x4 x4	x2 x2	x2

Kit



3

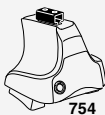

754

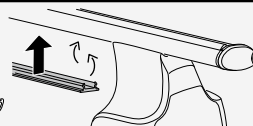
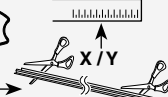

750



1

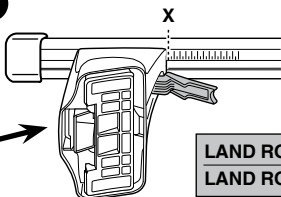
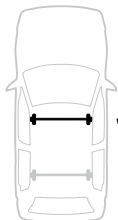

2

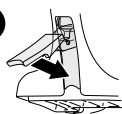

LAND ROVER Freelander 2, 5-dr SUV, 07-	X
LAND ROVER LR2, 5-dr SUV, *07-	45.5

1

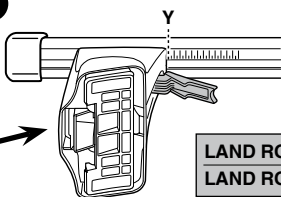

2

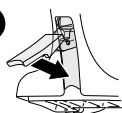

LAND ROVER Freelander 2, 5-dr SUV, 07-	Y
LAND ROVER LR2, 5-dr SUV, *07-	42.5



480R



480

1

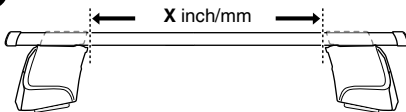

2

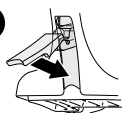

	X inch	X mm
LAND ROVER Freelander 2, 5-dr SUV, 07-	43 1/2"	1106 mm
LAND ROVER LR2, 5-dr SUV, *07-	43 1/2"	1106 mm

1

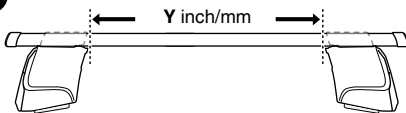

2

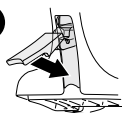

	Y inch	Y mm
LAND ROVER Freelander 2, 5-dr SUV, 07-	42 3/8"	1076 mm
LAND ROVER LR2, 5-dr SUV, *07-	42 3/8"	1076 mm

4

LAND ROVER Freelander 2, 5-dr SUV, 07-
 LAND ROVER LR2, 5-dr SUV, *07-

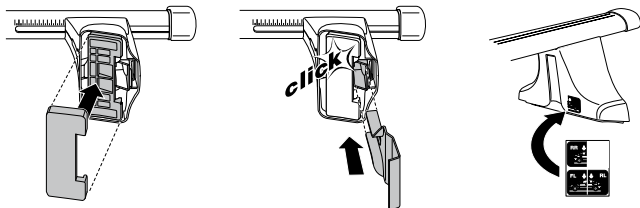
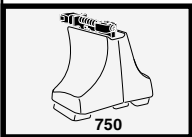
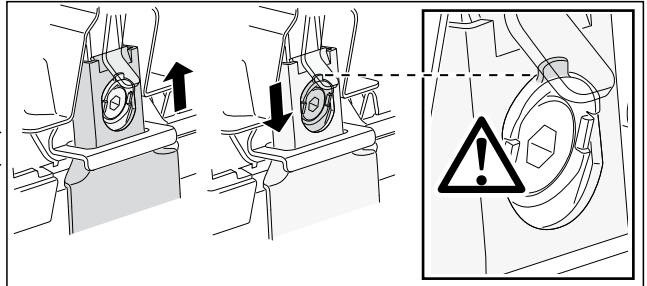
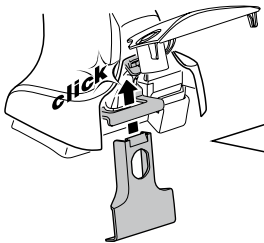
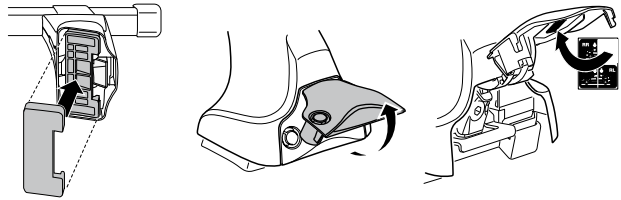
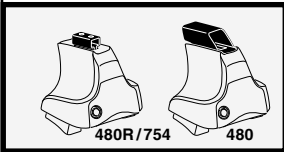
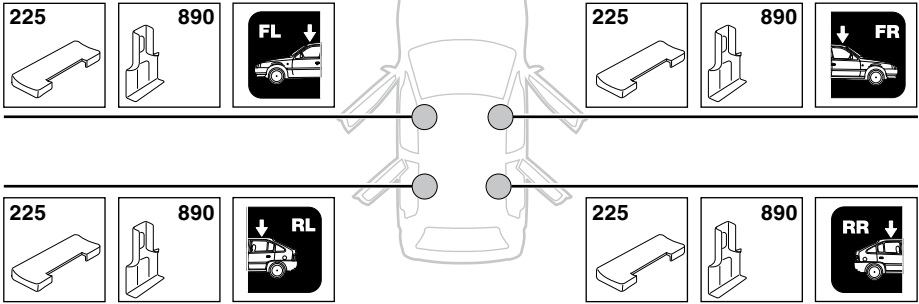

5



	X mm	Y mm	X inch	Y inch
LAND ROVER Freelander 2, 5-dr SUV, 07-	310 mm	700 mm	12 1/4"	27 1/2"
LAND ROVER LR2, 5-dr SUV, *07-	310 mm	700 mm	12 1/4"	27 1/2"

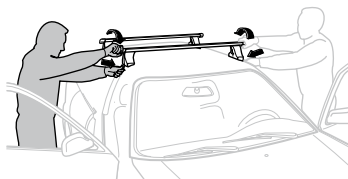
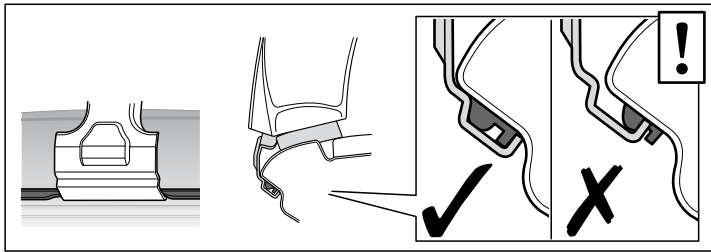
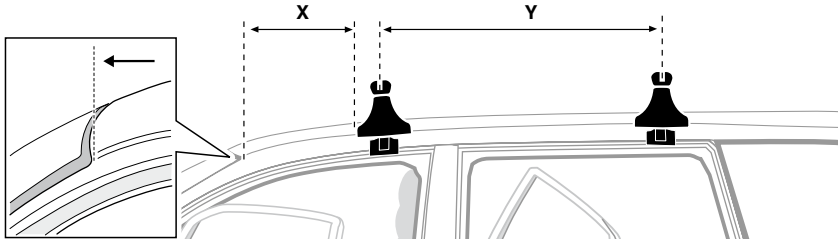

GB/US Tighten alternately

D Die Schrauben abwechselnd anziehen

F Serrer alternativement chaque côté

NL Afwisselend aan de linker- en de rechterkant aandraaien

I Alternare il serraggio delle viti

E Serrare alternativamente

PT Aperte alternadamente

S Dra åt växelvis

FIN Kierrä vuorotellen

EST Pinguldage vaheldumisi

LAT Pielieciet pamišus

LIT Užsukinėkite pakaitomis

PL Śruby dokręcaj naprzemiennie

RU Затягивайте попеременно

CZ Pokręťta багаžníka dokręcaj dokręcaj naprzemiennie.

SK Doťahujte striedavo

SLO Privijajte izmenično.

HR Naizmjenično zategnite

HU Egymástól függetlenül szorítandó

GR Σφιγγετε εναλλάξ

TR Dönüşümlü sıkın

中文 交替拧紧

한국어 번갈아 가며 조이십시오.

日本語 交互に締め付けてください。

ไทย ชั้้นโน้แบบสลับ

6

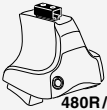

480R/754



480

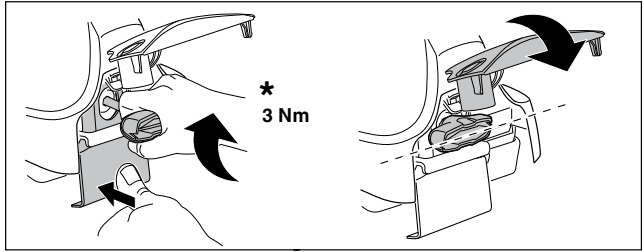
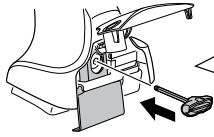

*
3 Nm



*

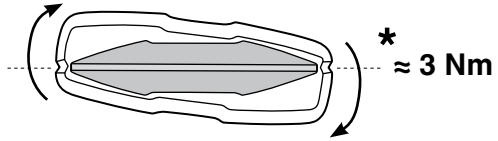

*
≈ 3 Nm

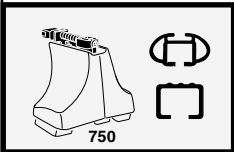
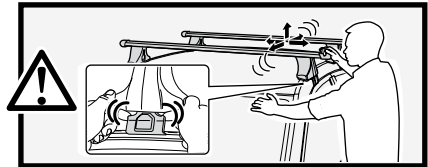

750

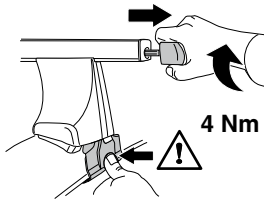

4 Nm

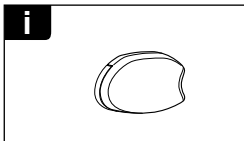
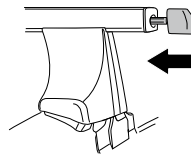

i

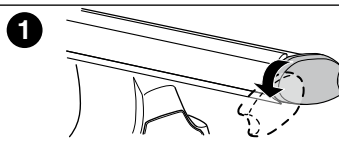

1

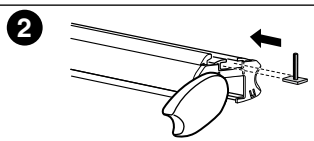

2

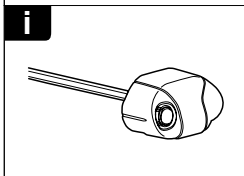

i

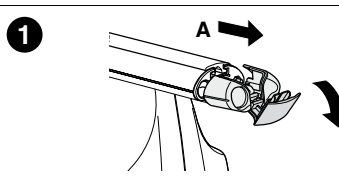

1

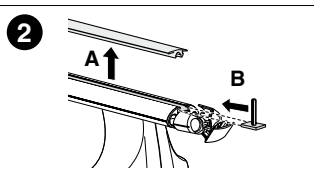

2

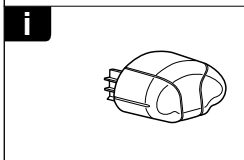

i

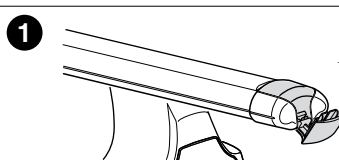

1

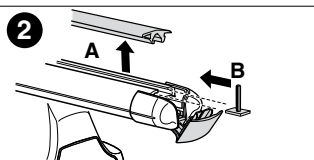

2

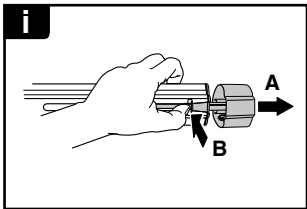
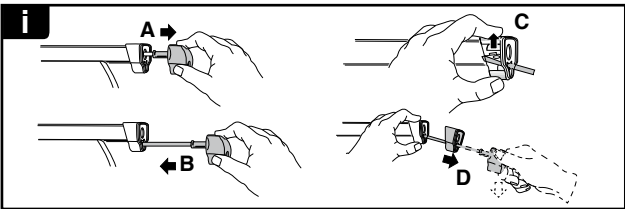
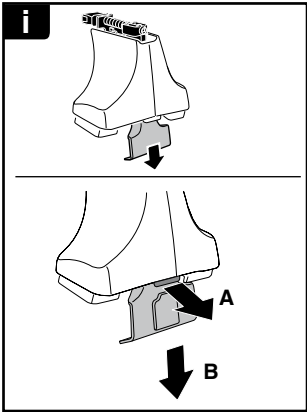
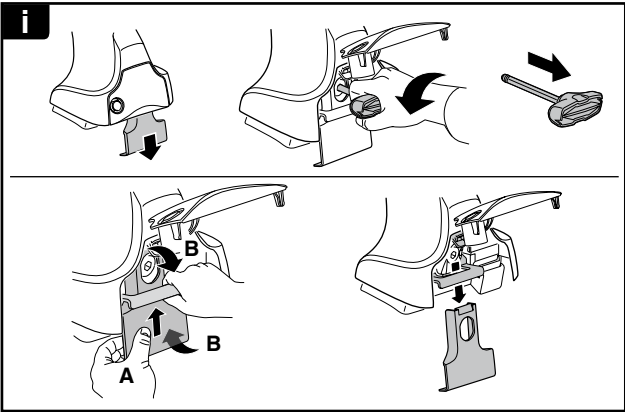
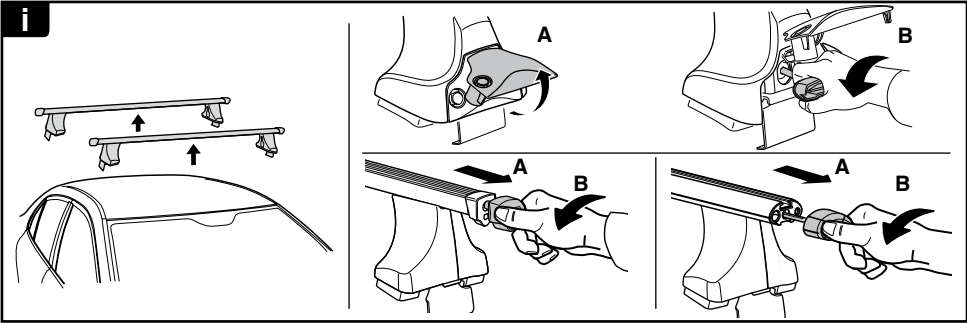

THULE
SWEDEN
**ONE
KEY
SYSTEM**

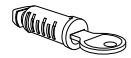
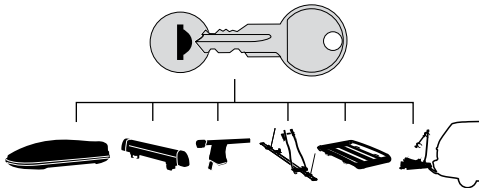

- 544** (x4)
- 596** (x6)
- 588** (x8)
- NA **510** (x10)
- EUR **510** (x10)
- ASIA **452** (x12)

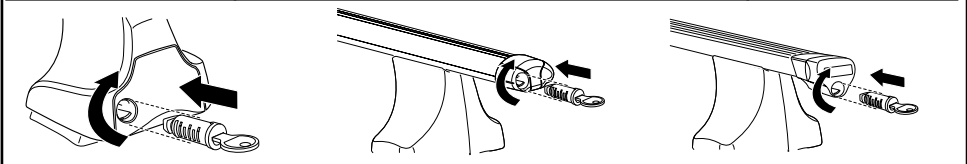

ww ▶ Thule Sweden AB, Box 69, 330 33 Hillerstorp, SWEDEN
NA ▶ Thule Inc., 42 Silvermine Road, Seymour, Connecticut 06483, USA

info@thule.com
customer.service@thule.com

 www.thule.com