

Kit 1621

VOLKSWAGEN Tiguan, 5-dr SUV, 07- (With Normal roof)



754 Rapid System
480R Rapid Traverse (North America)



480 Traverse (North America)

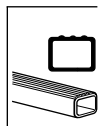

754 Rapid System
480R Rapid Traverse (North America)

754 Rapid System
480R Rapid Traverse (North America)
480 Traverse (North America)

(North America)

1202 x 1
1203 x 1
1207 x 2
52 x 2
120 x 1
121 x 1

1



2



754 Rapid System
480R Rapid Traverse
(North America)



x4

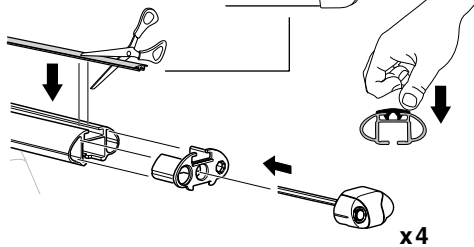
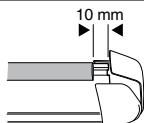

x4

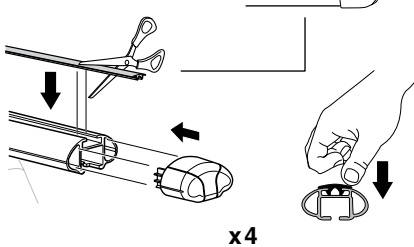
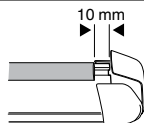
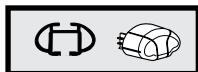

x4



480 Traverse
(North America)

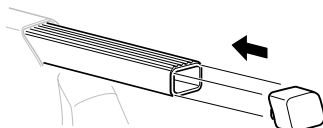
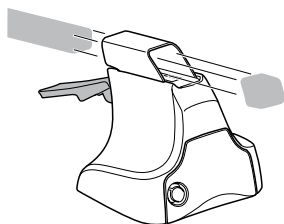

x4

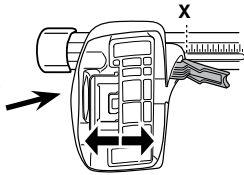
3**754** Rapid System

	X
VOLKSWAGEN Tiguan, 5-dr SUV, 07- (With Normal roof)	43

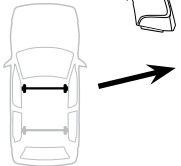

	Y
VOLKSWAGEN Tiguan, 5-dr SUV, 07- (With Normal roof)	37

3**480R** Rapid Traverse**480** Traverse**(North America)**

	X inch	X mm
VOLKSWAGEN Tiguan, 5-dr SUV, 07- (With Normal roof)	42 1/2"	1081 mm

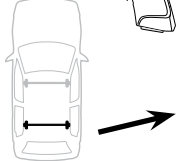

	Y inch	Y mm
VOLKSWAGEN Tiguan, 5-dr SUV, 07- (With Normal roof)	40 1/4"	1021 mm

4

5

VOLKSWAGEN Tiguan, 5-dr SUV, 07- (With Normal roof)

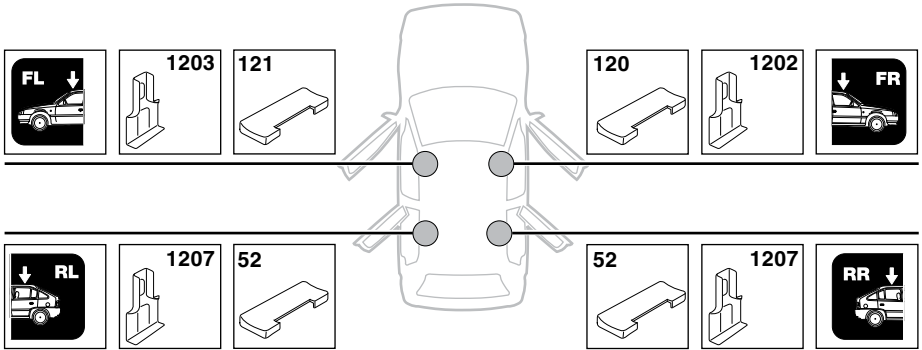

6

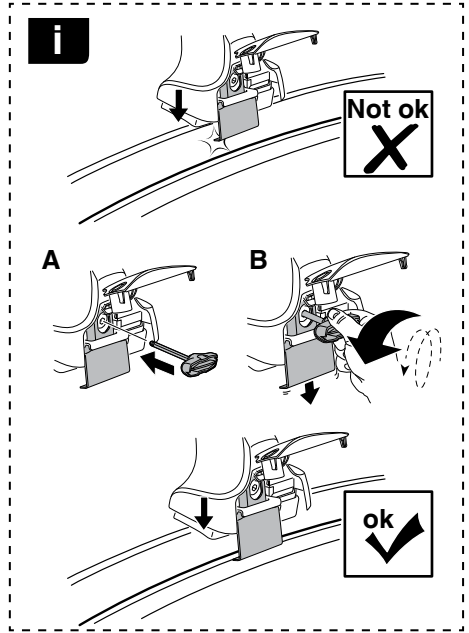

	X mm	Y mm	X inch	Y inch
VOLKSWAGEN Tiguan, 5-dr SUV, 07- (With Normal roof)	315 mm	700 mm	12 3/8"	27 1/2"

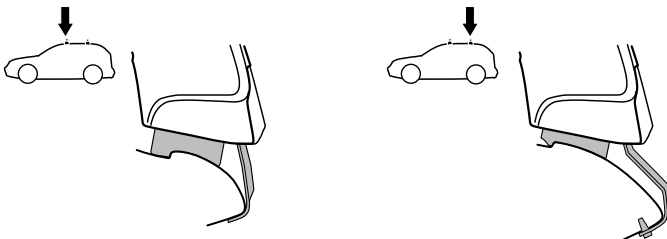
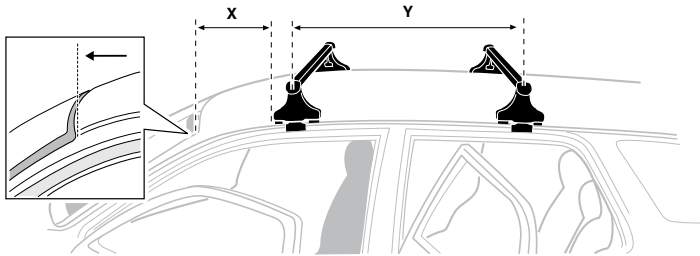

7



GB/US	Tighten alternately
D	Die Schrauben abwechselnd anziehen
F	Serrer alternativement chaque côté
NL	Afwisselend aan de linker- en de rechterkant aandraaien
I	Alternare il serraggio delle viti
E	Apertar alternativamente
PT	Aperte alternadamente
S	Dra åt växelvis
FIN	Kierrä vuorotellen
EST	Pinguldage vaheldumisi
LAT	Pielveiciet pamišus
LIT	Užsukinėkite pakaitomis
PL	Śruby dokręcaj naprzemiennie
RU	Загряивайте попеременно

CZ	Pokręřta bagažníka dokręřcaj dokręřcaj naprzemiennie.
SK	Dofahajte striedavo
SLO	Privijajte izmenično.
HR	Naizmjenočno zategnite
HU	Egymástól függetlenül szorítandó
GR	Σφιγίγτες εναλλάξ
TR	Dönüşümlü sıkın

中文 交替拧紧

한국어 번갈아 가며 조이십시오.

日本語 交互に締め付けてください。

ไทย ชันในแบบสลับ

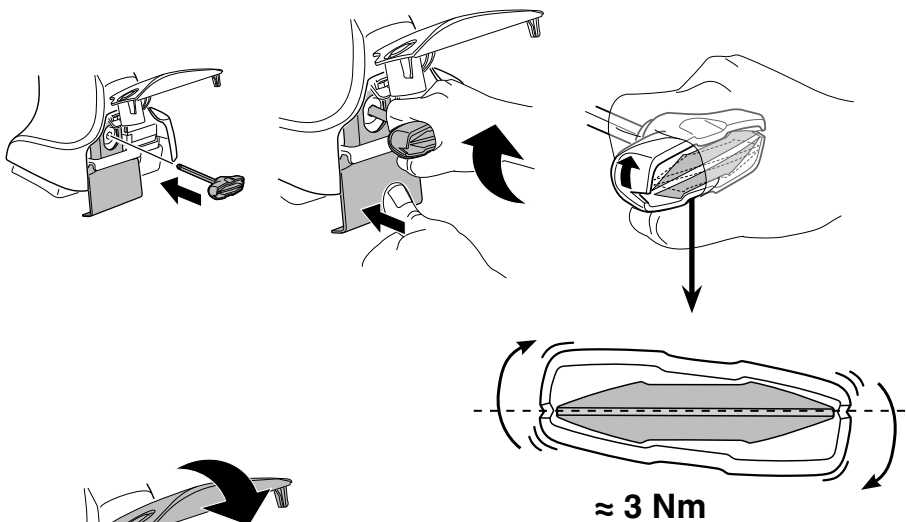

8

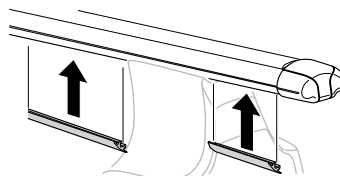
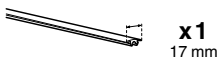

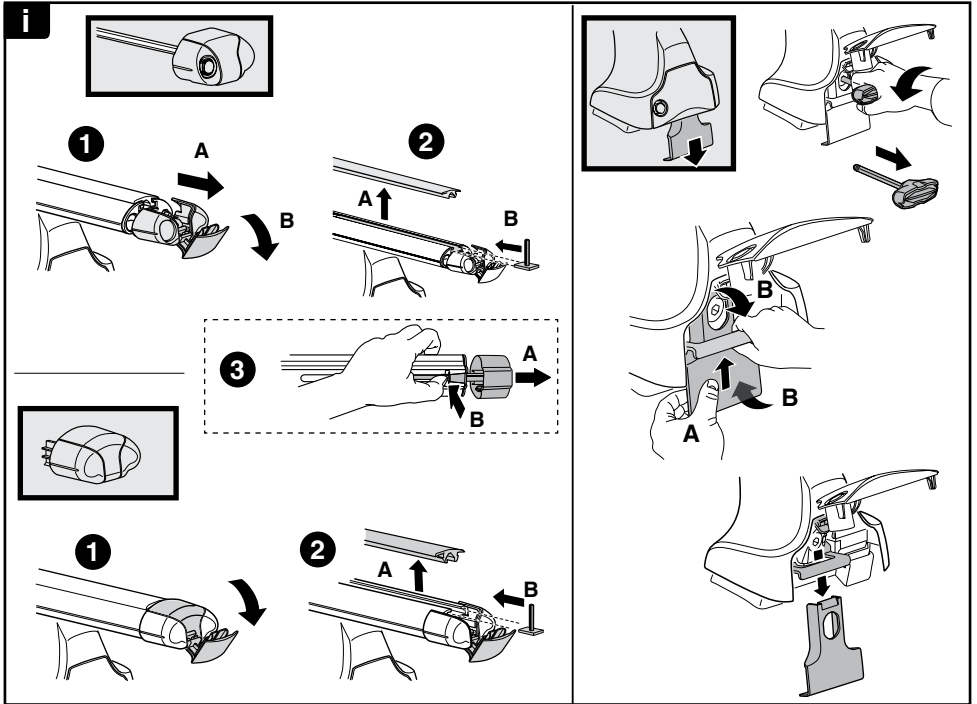
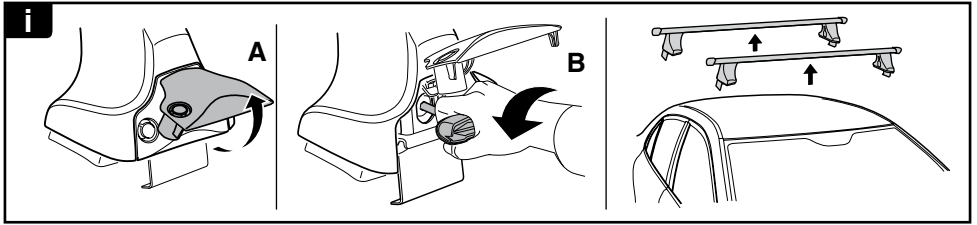

THULE
SWEDEN
**ONE
KEY
SYSTEM**

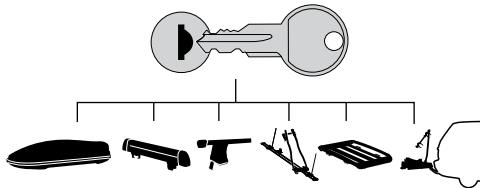

544 (x4)

596 (x6)

588 (x8)

NA **510** (x10)

EUR **452** (x12)

ASIA

