

# Kit 1640

**KIA Sportage, 5-dr SUV, 10- (Without railing)**

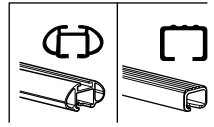

**754** Rapid System  
**480R** Rapid Traverse (North America)



**480** Traverse (North America)

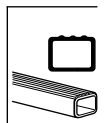

- 754 Rapid System: x1 (box), x4 (cubes), x4 (rings)
- 480R Rapid Traverse (North America): x4 (units), x4 (screws)
- 754 Rapid System: x1 (ruler)
- 480R Rapid Traverse (North America): x4 (units), x4 (screws)
- 480 Traverse (North America): x1 (ruler), x4 (units), x4 (screws)

- Bar: x2
- Hardware: x2 (23 mm), x2 (23 mm), x4 (screws), x4 (nuts)
- Hardware: x1 (17 mm), x2 (23 mm), x2 (23 mm), x2 (nuts)
- Hardware: x2 (23 mm), x2 (nuts)
- (North America): x2 (hardware), x2 (bar), x2 (hardware)

- Foot: 297 x4
- Plate: 52 x4
- Diagram: x1 (FR, FL, RL, RR)

1



2



754 Rapid System  
480R Rapid Traverse  
(North America)



x4



x4

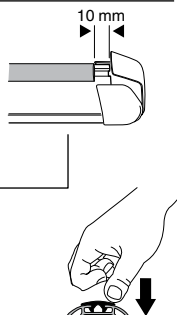

x4



480 Traverse  
(North America)



x4

**3****754** Rapid System

	<b>X</b>
<b>KIA Sportage, 5-dr SUV, 10-</b>	<b>43,5</b>

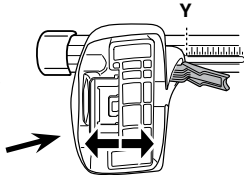

	<b>Y</b>
<b>KIA Sportage, 5-dr SUV, 10-</b>	<b>39,5</b>

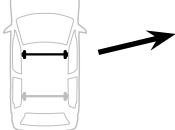
**3****480R** Rapid Traverse**480** Traverse**(North America)**

	<b>X inch</b>	<b>X mm</b>
<b>KIA Sportage, 5-dr SUV, 10-</b>	<b>42 3/4"</b>	<b>1086 mm</b>

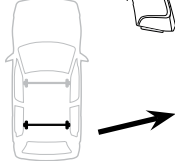

	<b>Y inch</b>	<b>Y mm</b>
<b>KIA Sportage, 5-dr SUV, 10-</b>	<b>41 1/8"</b>	<b>1046 mm</b>

**4**

# 5

KIA Sportage, 5-dr SUV, 10-

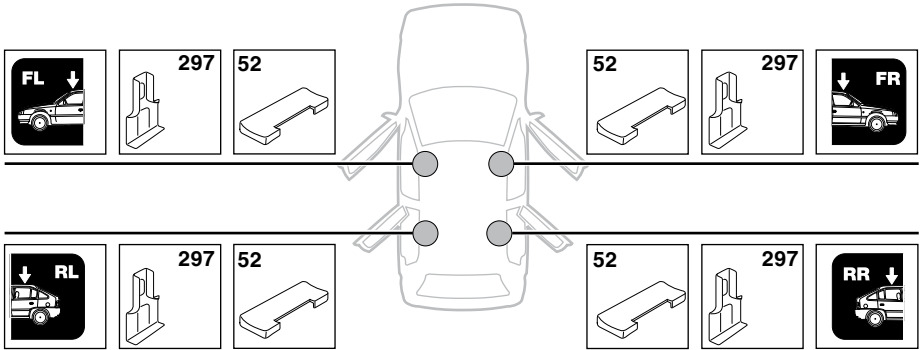

6

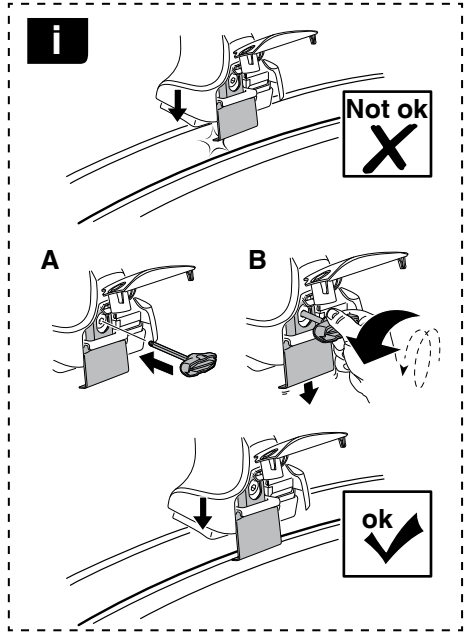
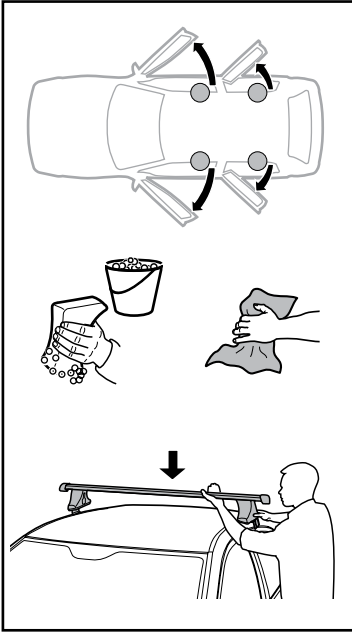

KIA Sportage, 5-dr SUV, 10-

X mm

Y mm

X inch

Y inch

360 mm

700 mm

14 1/8"

27 1/2"

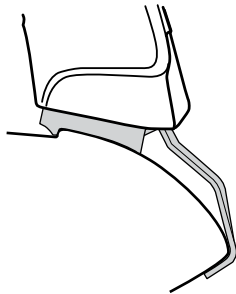
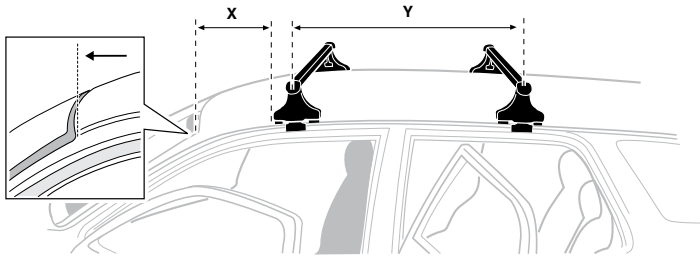

7



<b>GB/US</b>	Tighten alternately
<b>D</b>	Die Schrauben abwechselnd anziehen
<b>F</b>	Serrer alternativement chaque côté
<b>NL</b>	Afwisselend aan de linker- en de rechterkant aandraaien
<b>I</b>	Alternare il serraggio delle viti
<b>E</b>	Apertar alternativamente
<b>PT</b>	Aperte alternadamente
<b>S</b>	Dra åt växelvis
<b>FIN</b>	Kierrä vuorotellen
<b>EST</b>	Pinguldage vaheldumisi
<b>LAT</b>	Pielveiciet pamišus
<b>LIT</b>	Užsukinėkite pakaitomis
<b>PL</b>	Śruby dokręcaj naprzemiennie
<b>RU</b>	Загряивайте попеременно

<b>CZ</b>	Pokręřta багаžnika dokręcaj naprzemiennie.
<b>SK</b>	Dofahajte striedavo
<b>SLO</b>	Privijajte izmenično.
<b>HR</b>	Naizmjenično zategnite
<b>HU</b>	Egymástól függetlenül szorítandó
<b>GR</b>	Σφιγίγεται εναλλάξ
<b>TR</b>	Dönüşümlü sıkın

**中文** 交替拧紧

**한국어** 번갈아 가며 조이십시오.

**日本語** 交互に締め付けてください。

**ไทย** ชันในแบบสลับ

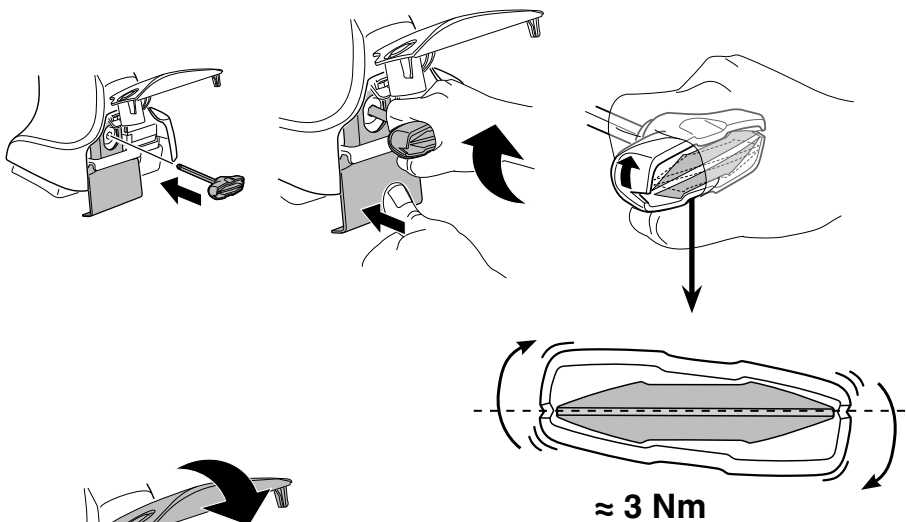

≈ 3 Nm

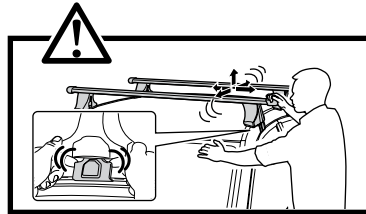

8



x1  
17 mm

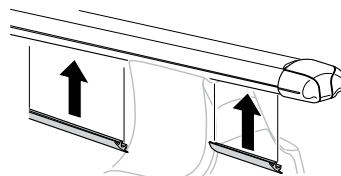
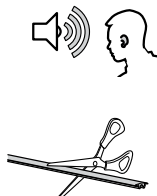



**THULE**  
SWEDEN  
**ONE  
KEY  
SYSTEM**



		(x4)
		(x6)
		(x8)
NA		(x10)
EUR		(x12)
ASIA		



WW ▶ Thule Sweden AB, Box 69, 330 33 Hillerstorp, SWEDEN  
NA ▶ Thule Inc., 42 Silvermine Road, Seymour, Connecticut 06483, USA

info@thule.com  
customer.service@thule.com

www.thule.com